

SCHEMAT ZABUDOWY

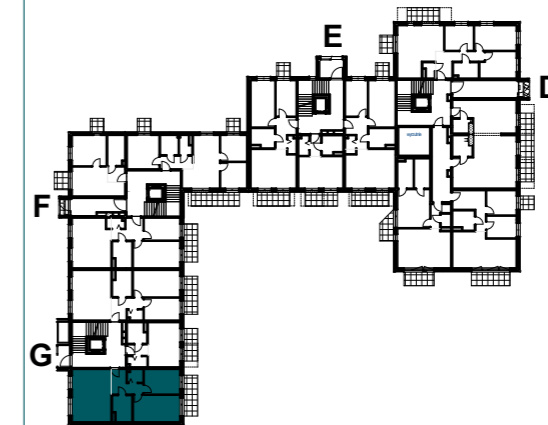

SCHEMAT KONDYGNACJI

bryła **B**

kondygnacja **PARTER**

klatka / nr lokalu **G / 126**

powierzchnia użytkowa **64,60m²**

INFORMACJE O LOKALU

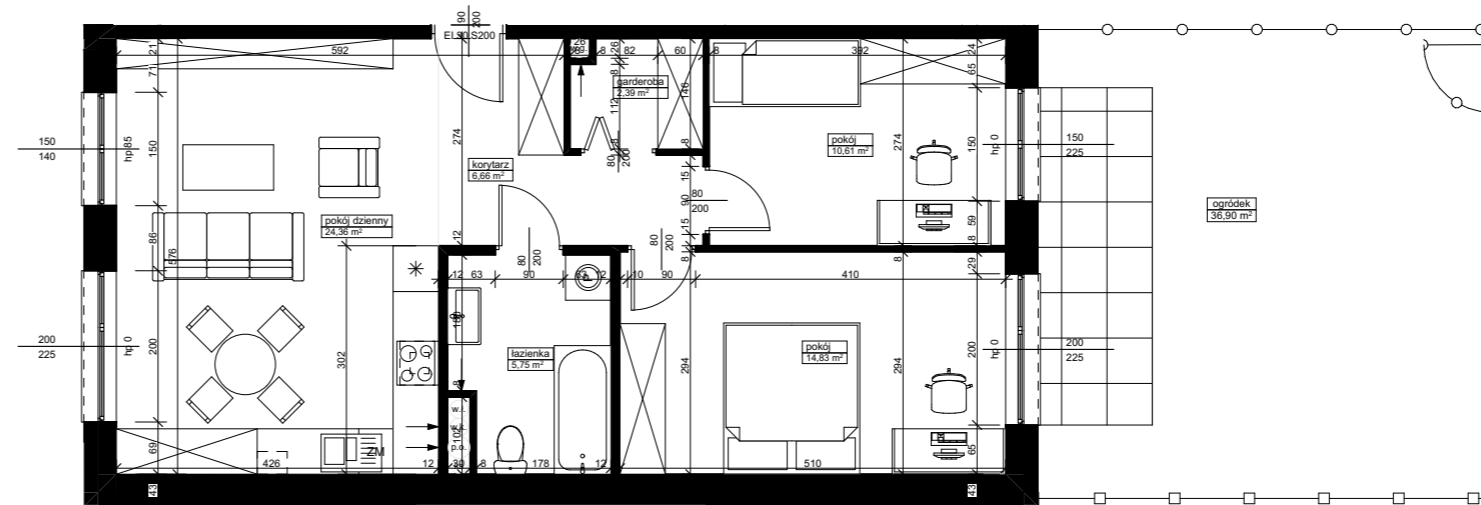





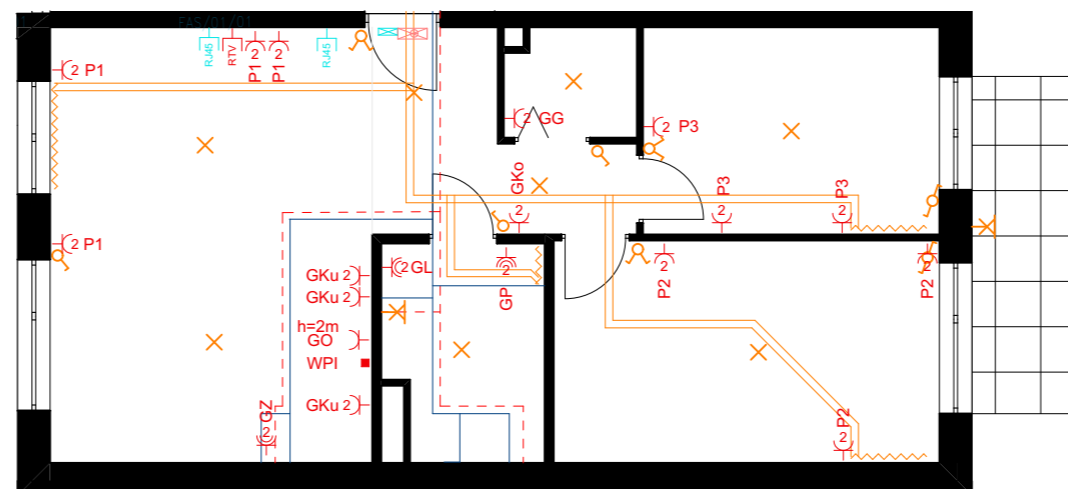
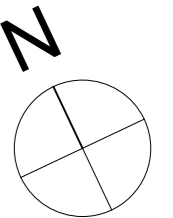











1:100

garderoba	2,39
korytarz	6,66
łazienka	5,75
pokój	10,61
pokój	14,83
pokój dzienny	24,36
	64,60 m²
ogródek	36,90



1:100

-  grzejnik
-  podejścia do grzejników
-  instalacja wody zimnej
-  instalacja wody ciepłej
-  gniazdo elektryczne pojedyncze
-  gniazdo elektryczne podwójne
-  gniazdo elektryczne pojedyncze IP44
-  gniazdo elektryczne podwójne IP44
-  gniazdo RTV
-  WPI wypust elektryczny
-  gniazdo RJ45
-  rozdzielnica
-  wypust oświetleniowy
-  wyłącznik pojedynczy
-  wyłącznik podwójny
-  kinkiet